

VENTURA / Foreman & Nicky Cook Patterns

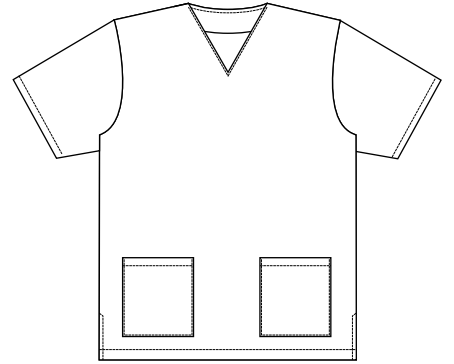

STYLE
Scrub Top

SIZES XS - XXL

RECOMMENDED FABRIC
150gsm 65% Polyester 35% Cotton Twill

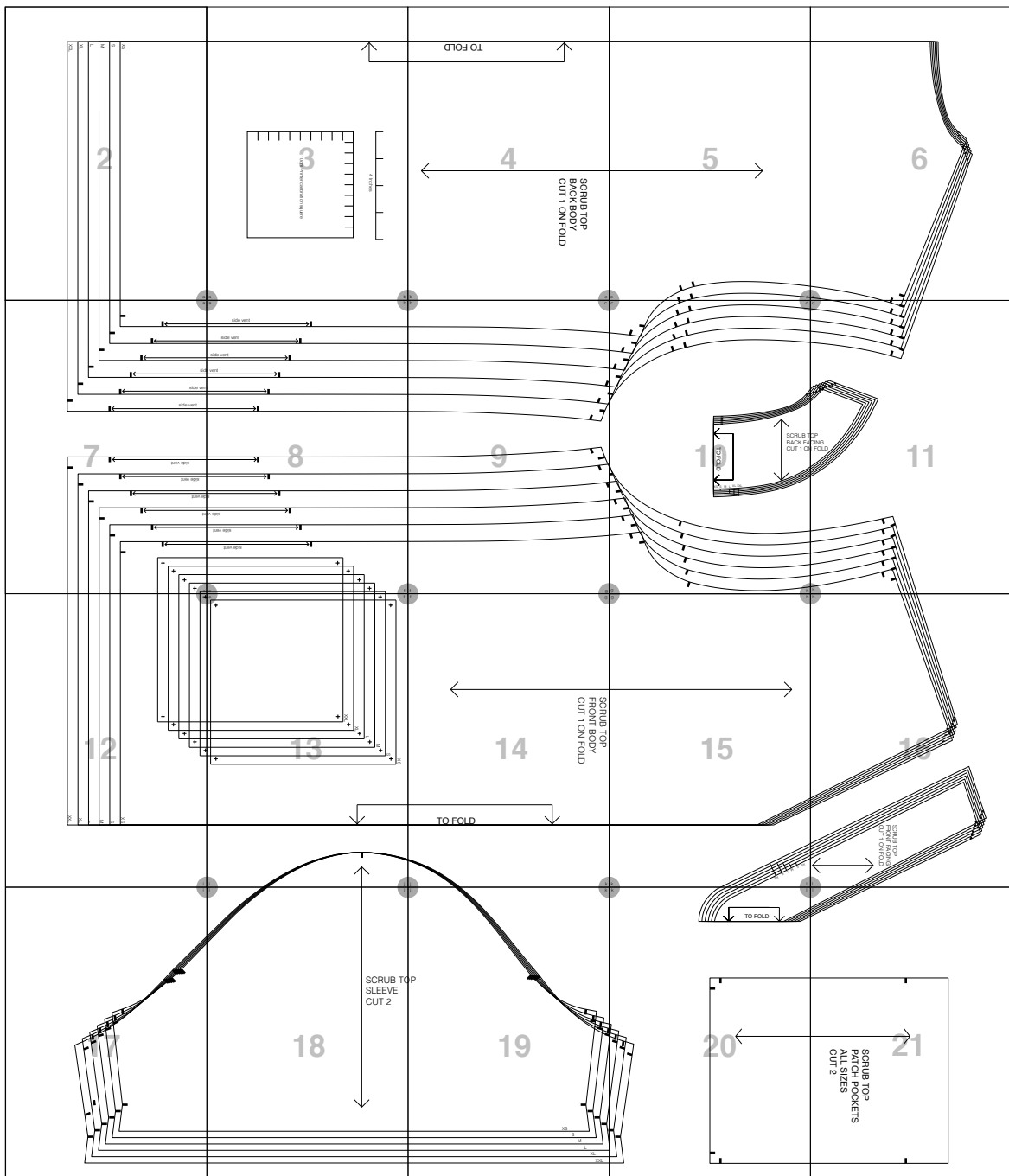

XXL

XL

L

M

S

SX

2

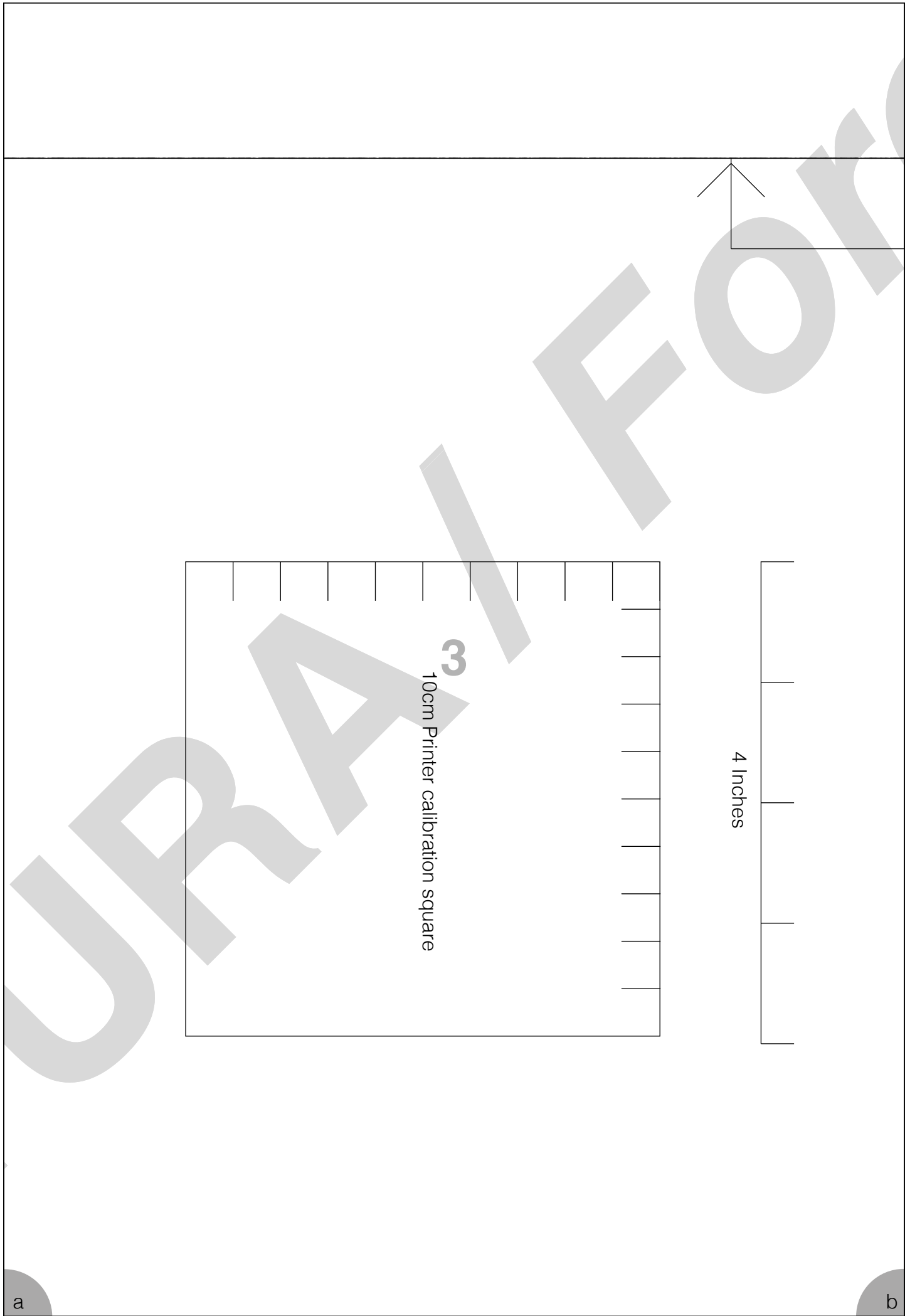

3
10cm Printer calibration square

4 Inches

a

b

TO FOLD



4

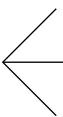

SCRUB TOP
BACK BODY
CUT 1 ON FOLD

5

Coop

Nicky

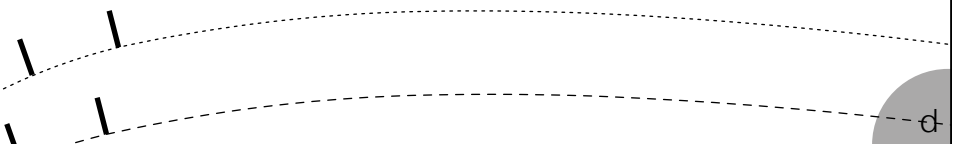

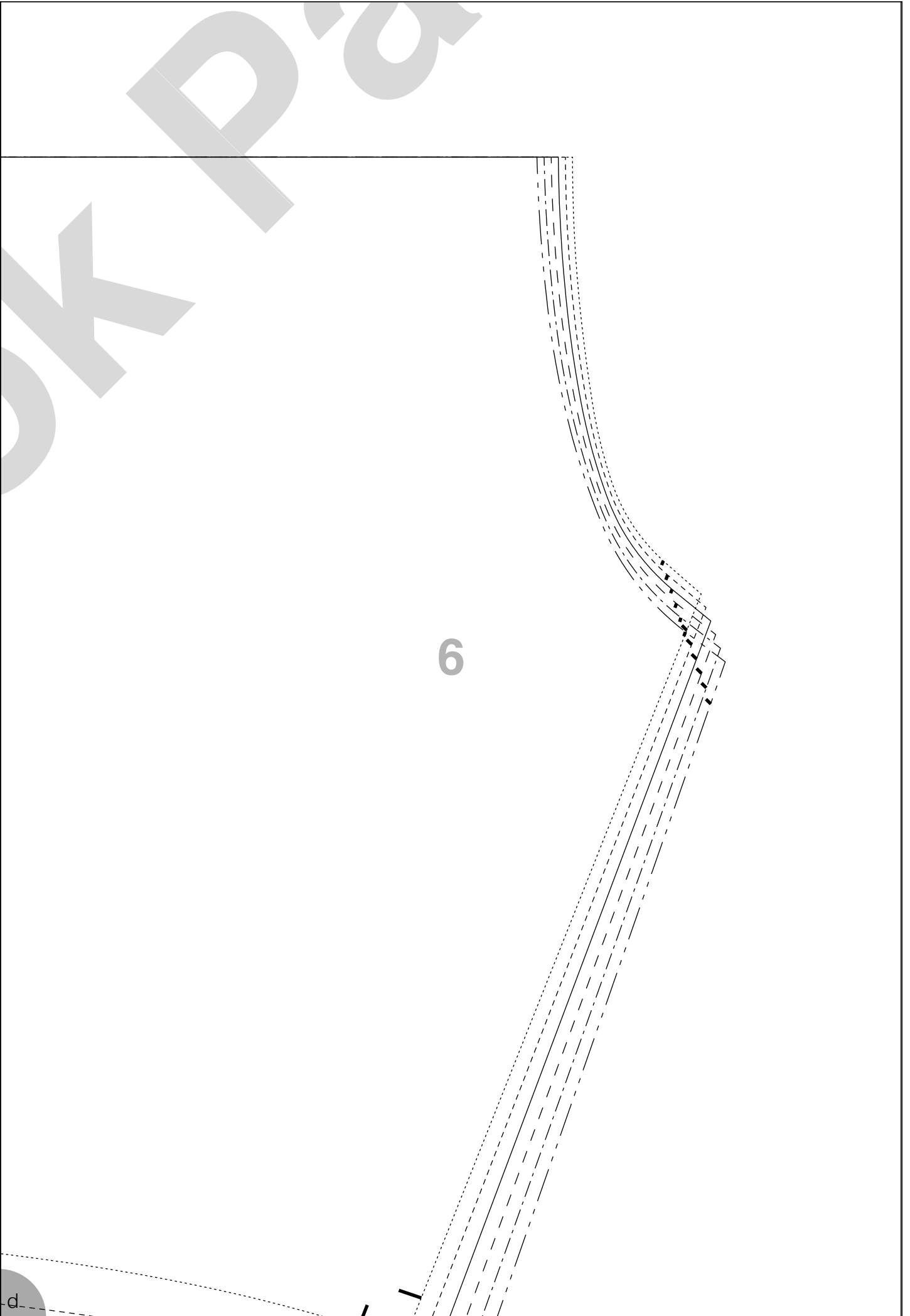

a

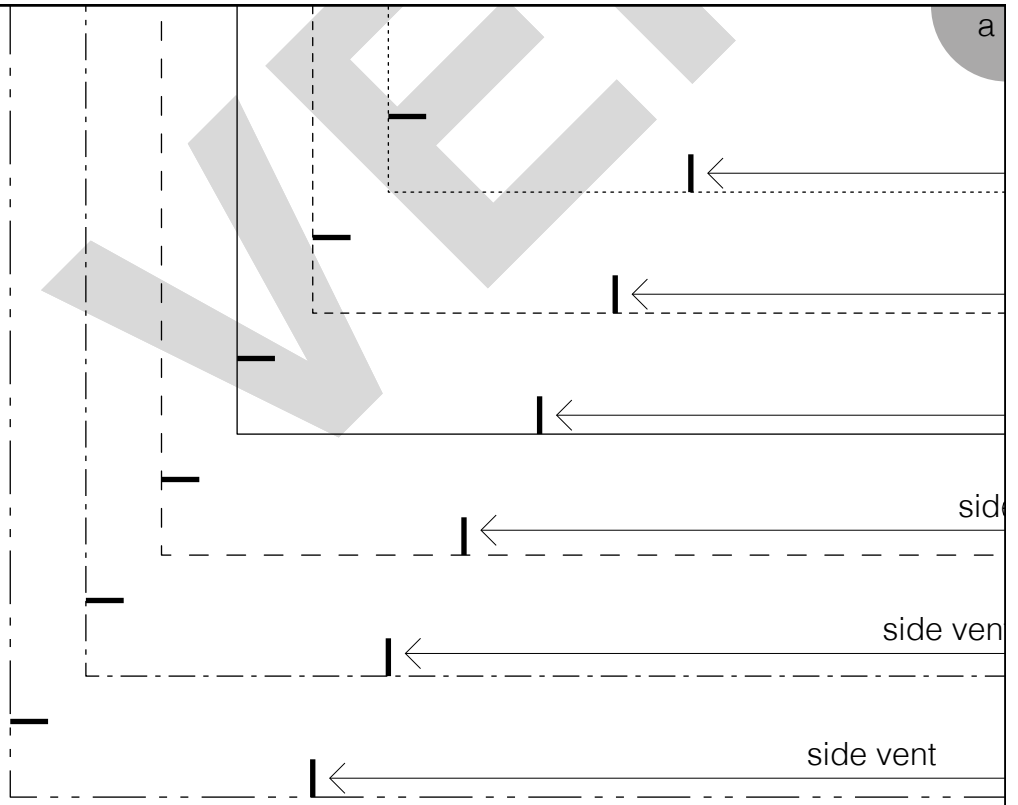

7

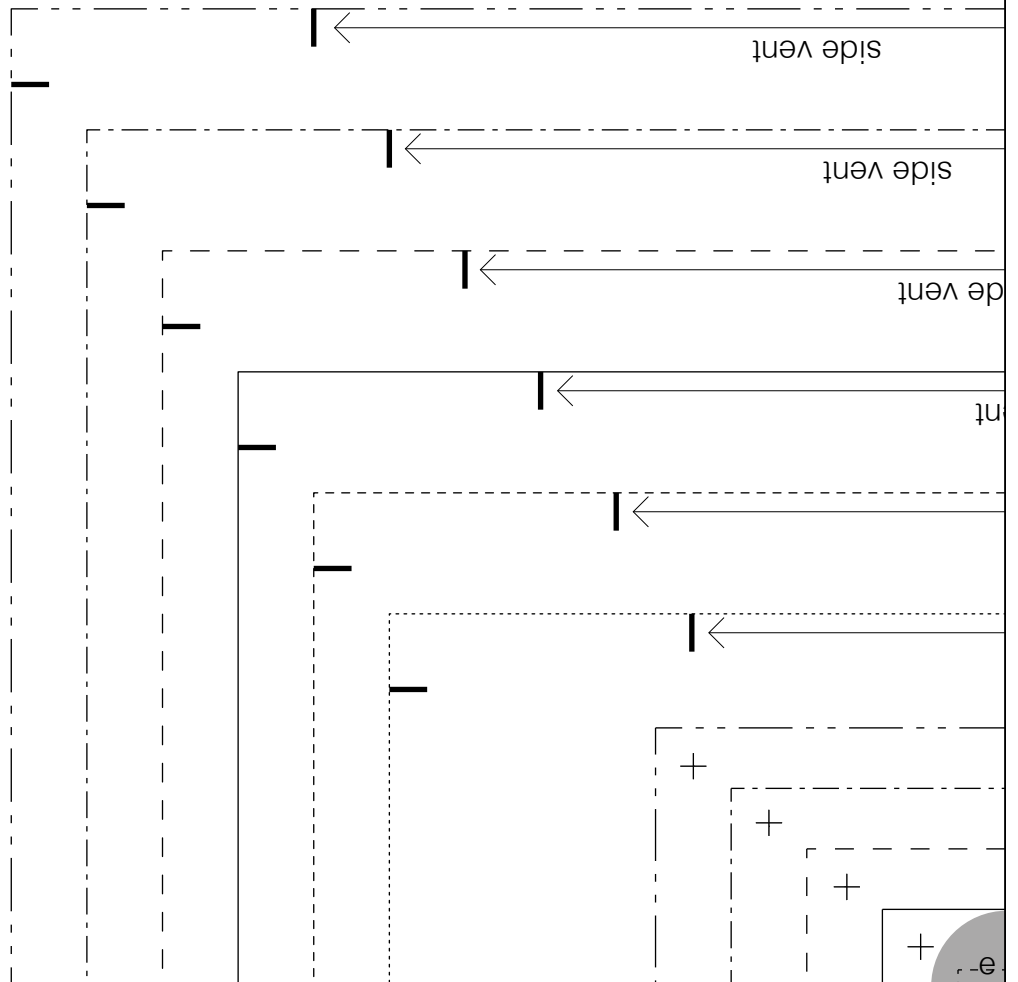

a

b

side vent



side vent



side vent



e vent

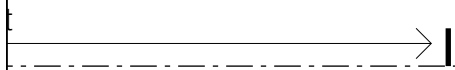

8



s



side ve



side vent



side vent

+

+

+

+

e

f

b

c

9

f

g

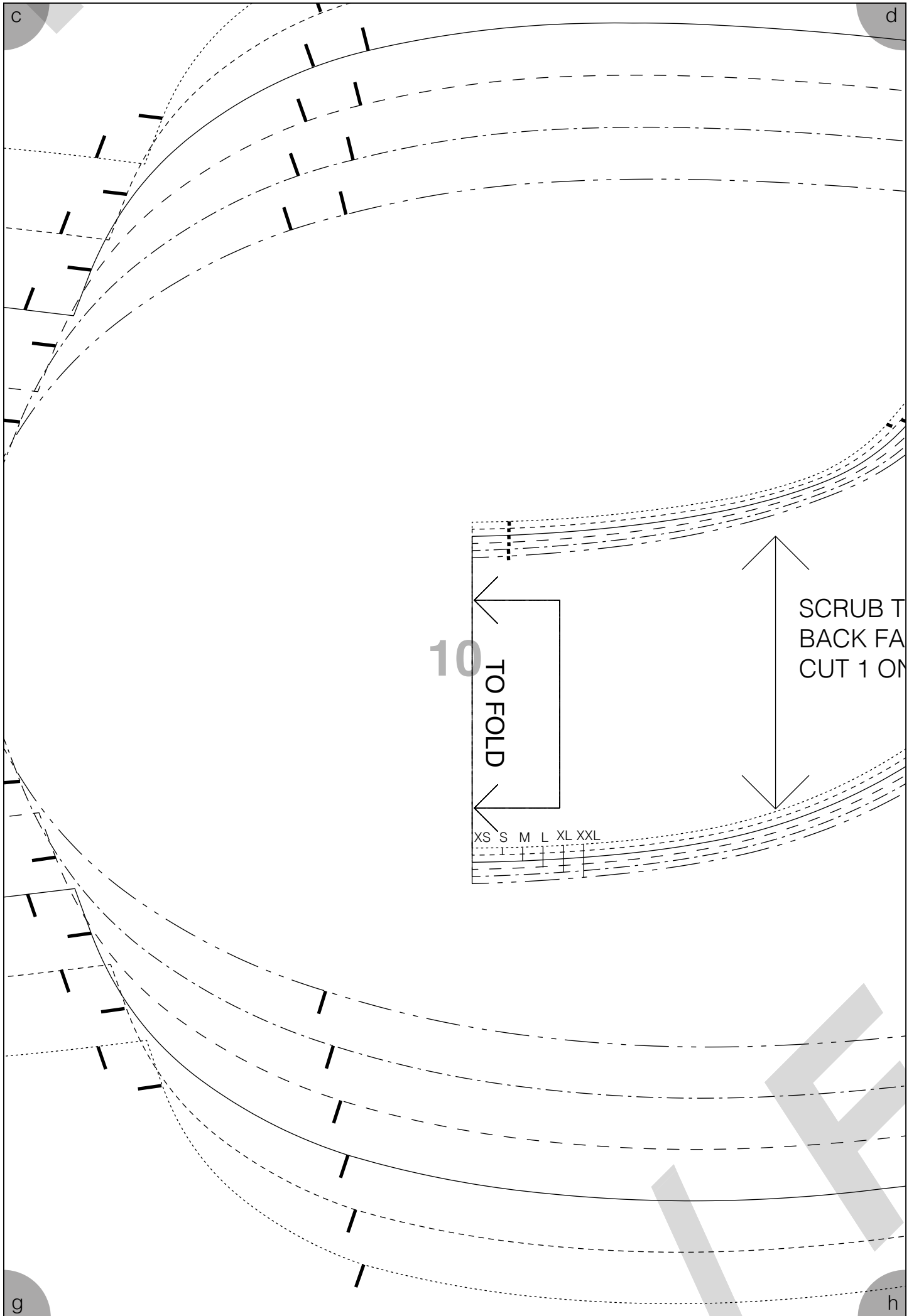

c

d

10

TO FOLD

SCRUB TOP
BACK PANEL
CUT 1 ON

XS S M L XL XXL

XS	S	M	L	XL	XXL
1	1	1	1	1	1

g

h

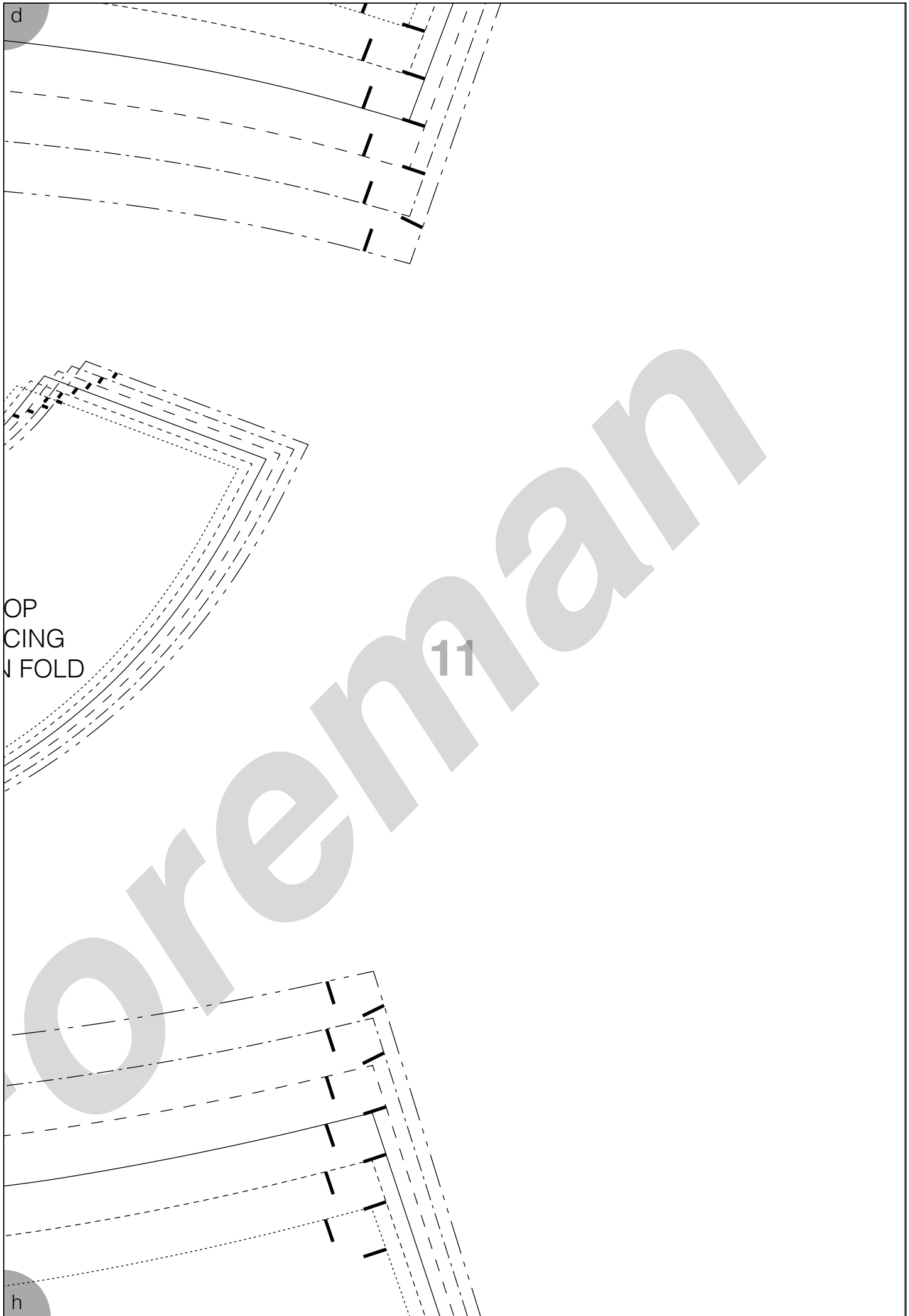

OP
CING
N FOLD

11

h

d

12

NICKY C

XX

X

T

M

S

SX

+

+

+

+

+

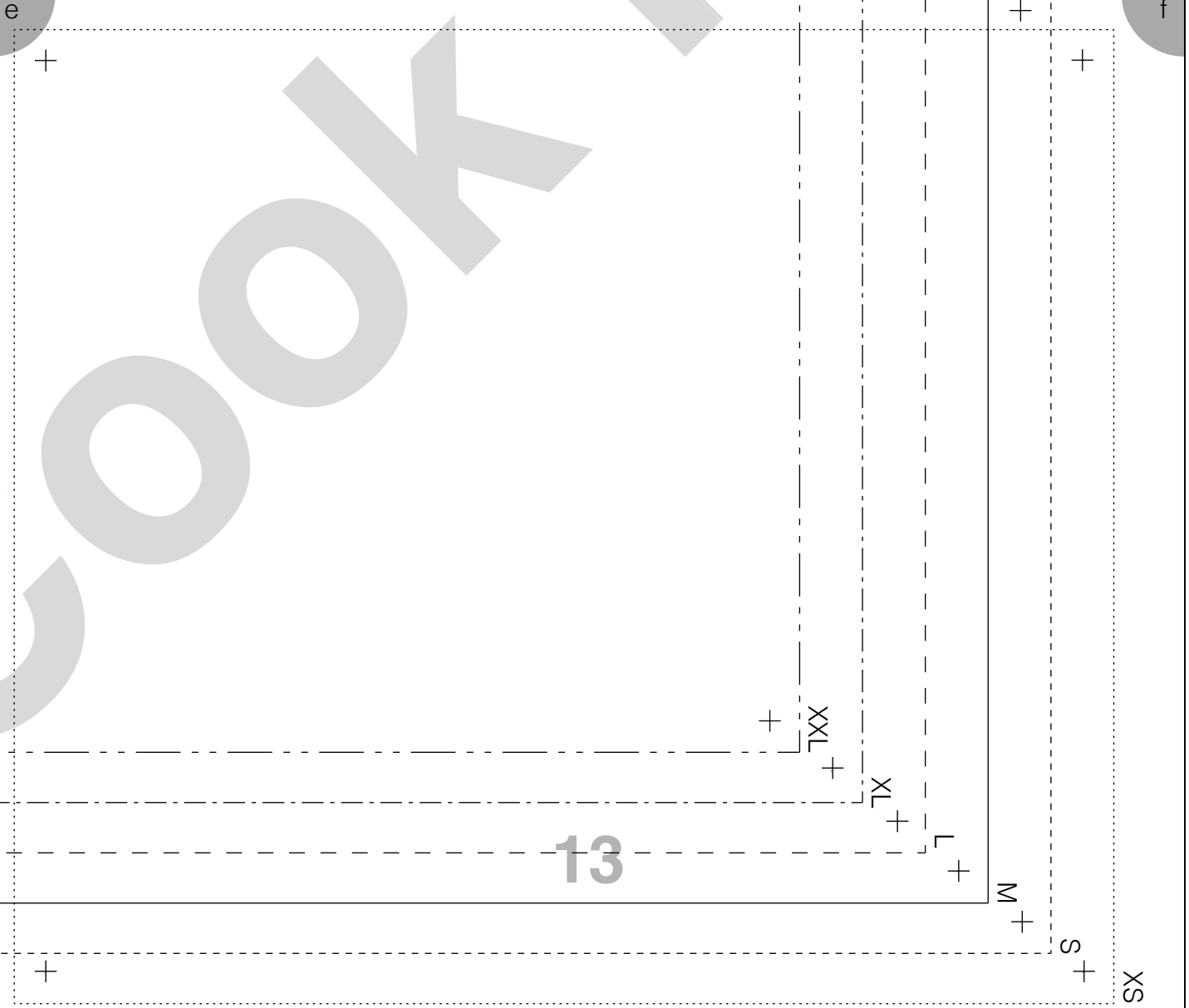

13

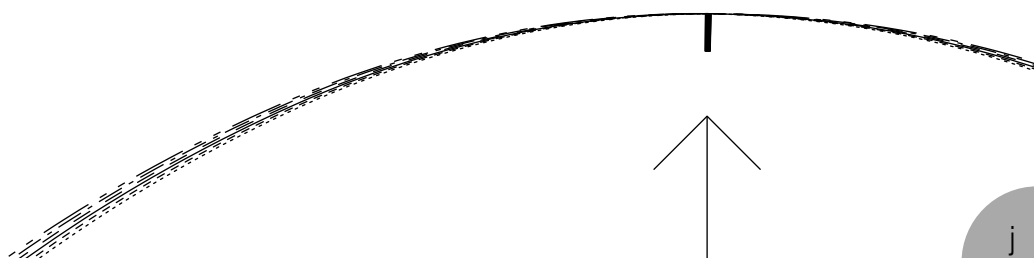
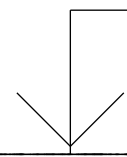

f

g

SCRUB TOP
FRONT BODY
CUT 1 ON FOLD

14

TO FOLD



j

k

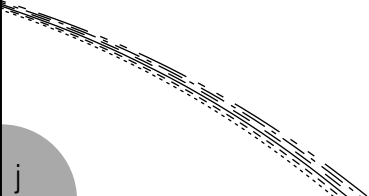

g

h

15

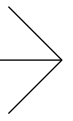

k

l

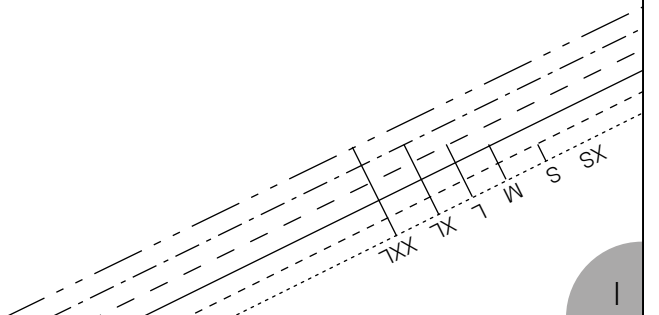
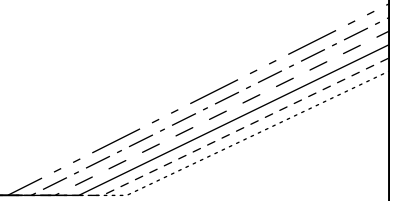

h

16

SCRUB TOP
FRONT FACING
CUT 1 ON FOLD

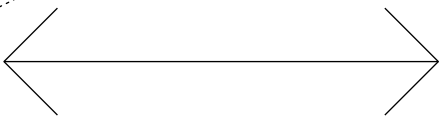

l

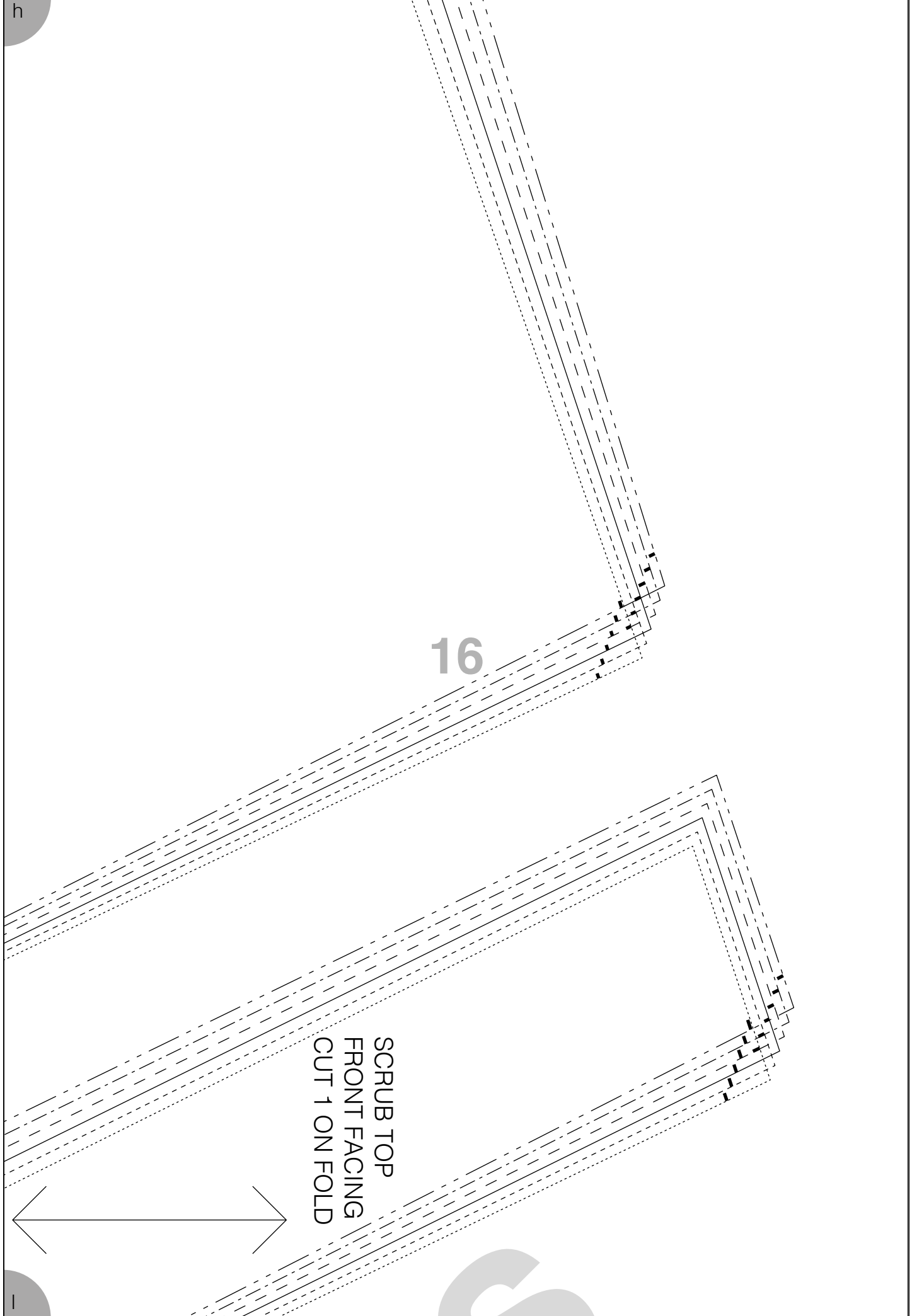

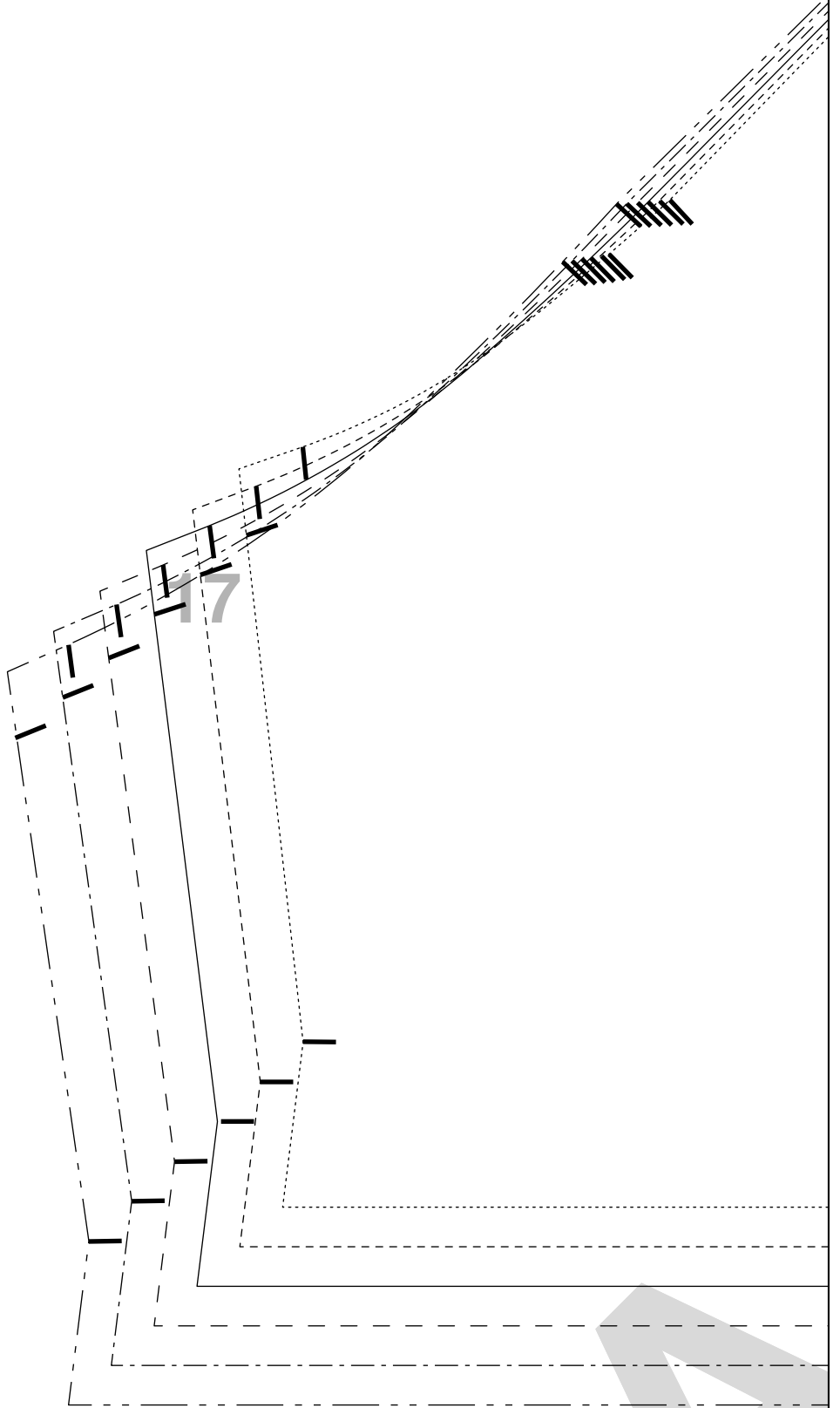

i

j

SCRUB TO
SLEEVE
CUT 2

18

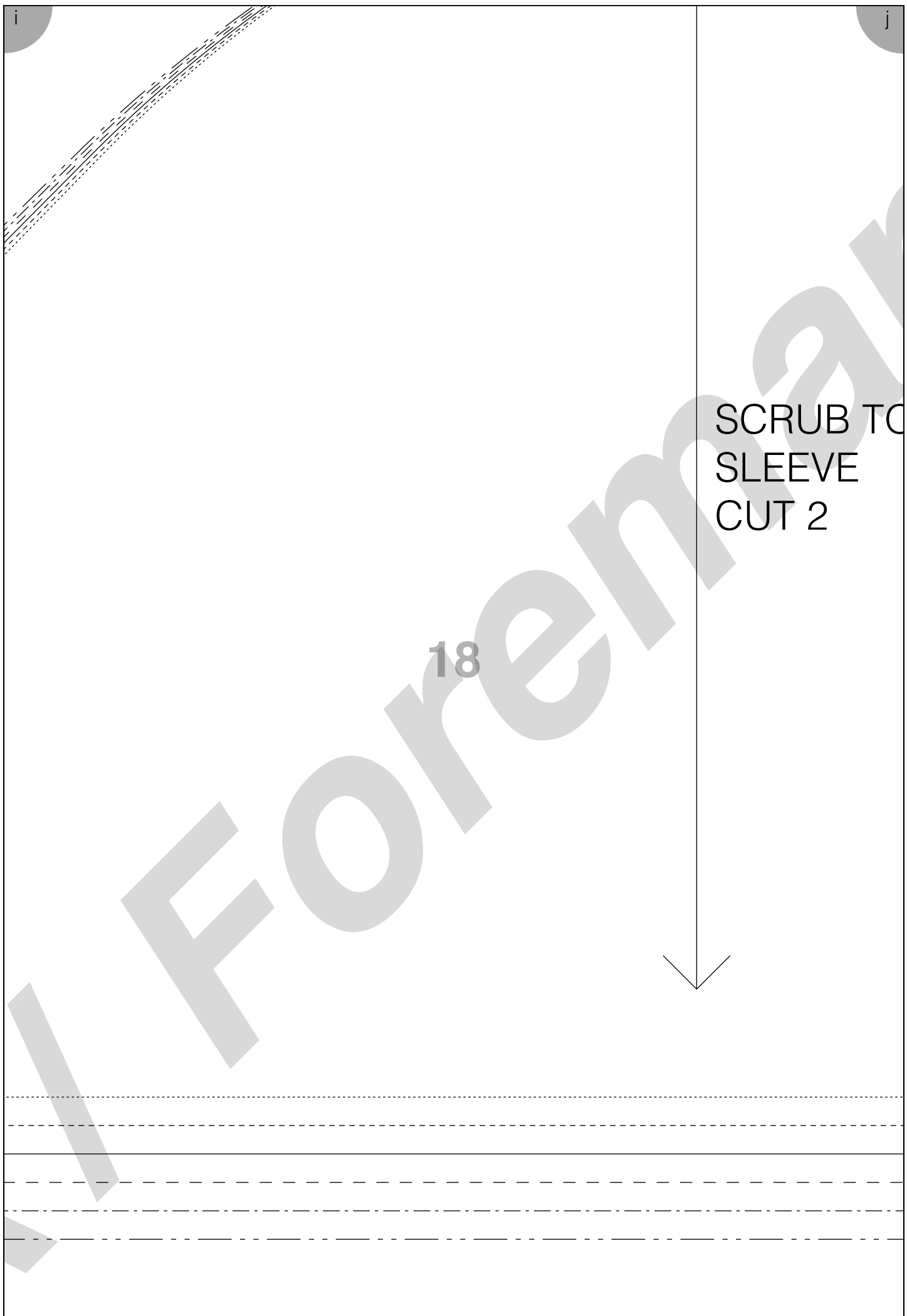
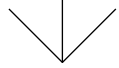

j

k

DP

19

XS

S

M

L

XL

XXL

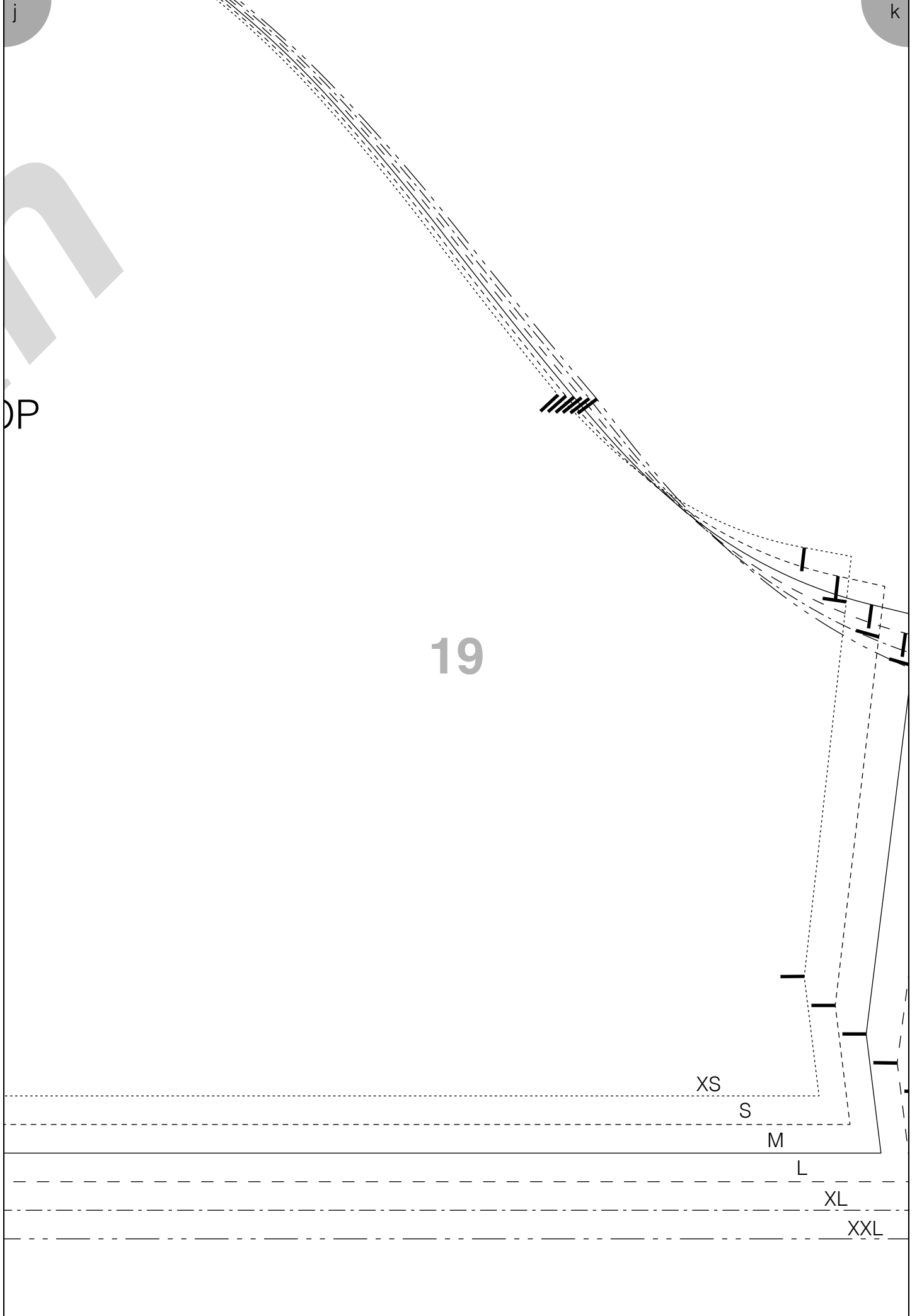

k

l

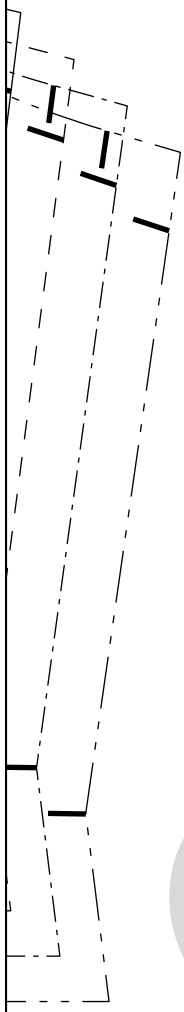
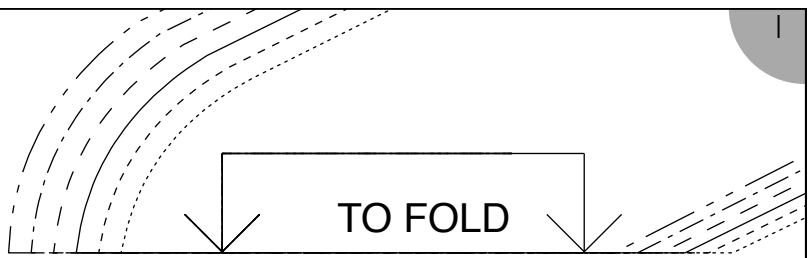

20

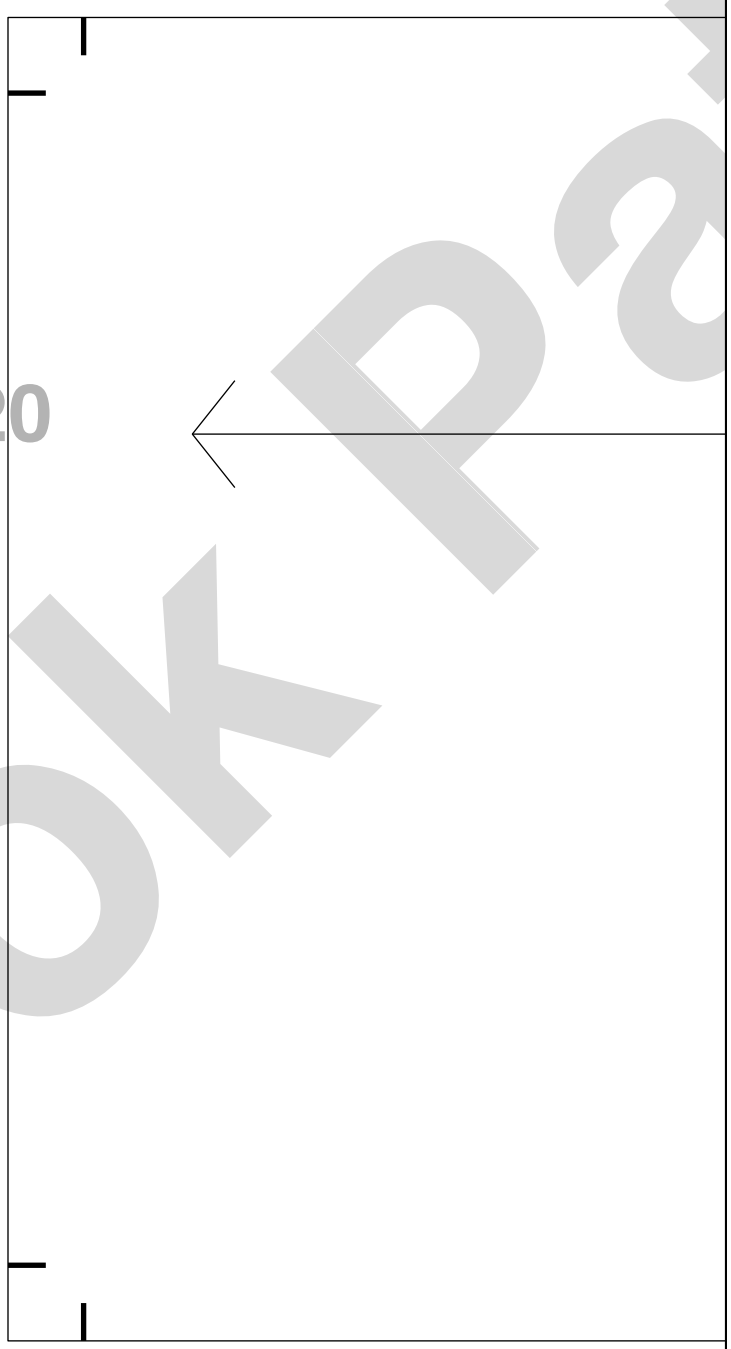

COOK P&P

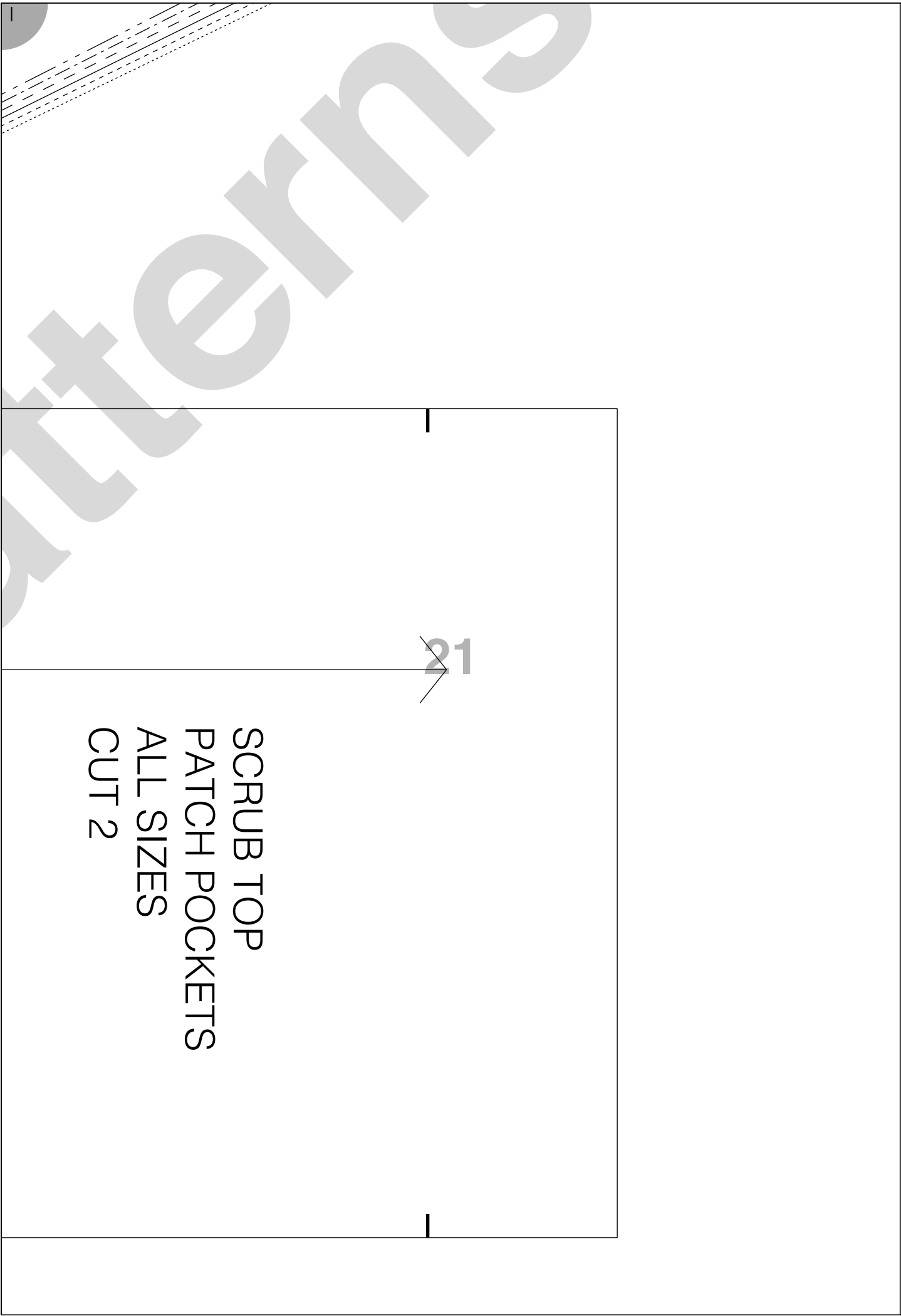

21

SCRUB TOP
PATCH POCKETS
ALL SIZES
CUT 2